



MAGTROL

MODEL 6200

Open Loop Dynamometer Controller



User's Manual

Purchase Record

Please record all model numbers and serial numbers of your Magtrol equipment, along with the general purchase information. The model number and serial number can be found on either a silver identification plate or white label affixed to each unit. Refer to these numbers whenever you communicate with a Magtrol representative about this equipment.

Model Number: _____

Serial Number: _____

Purchase Date: _____

Purchased From: _____

While every precaution has been exercised in the compilation of this document to ensure the accuracy of its contents, Magtrol, Inc. assumes no responsibility for errors or omissions. Additionally, no liability is assumed for any damages that may result from the use of the information contained within this publication.

COPYRIGHT

Copyright ©2002- 2014 Magtrol, Inc. All rights reserved.

Copying or reproduction of all or any part of the contents of this manual without the express permission of Magtrol is strictly prohibited.

TRADEMARKS

LabVIEW™ is a trademark of National Instruments Corporation.

Microsoft® is a registered trademark of Microsoft Corporation.

National Instruments™ is a trademark of National Instruments Corporation.

Windows® is a registered trademark of Microsoft Corporation.

Safety Precautions



1. Make sure that all Magtrol dynamometers and electronic products are earth-grounded, to ensure personal safety and proper operation.
2. Check line voltage before operating the 6200.
3. Make sure that dynamometers and motors under test are equipped with appropriate safety guards.

Revisions To This Manual

The contents of this manual are subject to change without prior notice. Should revisions be necessary, updates to all Magtrol User's Manuals can be found at Magtrol's web site at www.magtrol.com/support/manuals.htm.

Please compare the date of this manual with the revision date on the web site, then refer to the manual's Table of Revisions for any changes/updates that have been made since this edition.

REVISION DATE

1st Edition rev. A – March 2014

TABLE OF REVISIONS

Date	Edition	Change	Section(s)
03/03/14	1st Edition - rev. A	Torque Offset and Gain procedure updated.	6.3.2
03/03/14	1st Edition - rev. A	Basic Calibration Process updated.	6.3
03/03/14	1st Edition - rev. A	Accessory Torque/Speed Output diagram updated.	2.2.1

Table of Contents

SAFETY PRECAUTIONS	III
REVISIONS TO THIS MANUAL	IV
REVISION DATE.....	IV
TABLE OF REVISIONS	IV
PREFACE.....	VII
PURPOSE OF THIS MANUAL	VII
WHO SHOULD USE THIS MANUAL.....	VII
MANUAL ORGANIZATION	VII
CONVENTIONS USED IN THIS MANUAL	VIII
1. INTRODUCTION	9
1.1 UNPACKING YOUR 6200	9
1.2 FEATURES OF THE 6200.....	9
1.3 DATA SHEET.....	10
2. CONTROLS.....	12
2.1 FRONT PANEL.....	12
2.1.1 Front Panel Controls and Buttons	12
2.1.2 How to Use Front Panel Controls and Buttons	13
2.2 REAR PANEL.....	14
2.2.1 Rear Panel Functions.....	14
2.3 VACUUM FLUORESCENT DISPLAY (VFD).....	16
2.3.1 Contrast Settings	16
2.3.2 Displaying Desired Information.....	16
3. INSTALLATION	9
3.1 POWERING UP THE 6200	9
3.1.1 Setting Unit for Line Voltage	9
3.1.2 Hardware Connection.....	10
3.1.3 Self-Test	10
3.2 BASIC TEST SETUP.....	10
4. MANUALLY CONTROLLED OPERATION	11
4.1 SETTING DESIRED OPERATING PARAMETERS	11
4.1.1 Set Power Display to Desired Units (Watts, Hp or Aux.)	11
4.1.2 Set Display to Desired Torque Units.....	11
4.1.3 Set up System Parameters	11
4.1.4 Set Up Pass/Fail Parameters.....	11
4.1.5 Set Up I/O Parameters.....	12
4.2 SETTING DYNAMOMETER LOAD	12
4.3 USING INTERNAL MEMORY	13
4.3.1 Storing Data Points	13
4.3.2 Recalling Data Points.....	13
4.3.3 Exiting the Memory Mode.....	13
4.3.4 Clearing the Memory	13
5. COMPUTER CONTROLLED OPERATION	14
5.1 ABOUT THE GPIB INTERFACE.....	14

5.1.1	Installing the GPIB (IEEE-488) Connector Cable	14
5.1.2	Changing the GPIB Primary Address	15
5.2	CHECKING THE 6200-TO-PC CONNECTION	15
5.3	PROGRAMMING	16
5.4	6200 COMMAND SET	16
5.4.1	Command Set for 6200	16
5.5	ACQUIRING SPEED-TORQUE DATA	18
5.6	SELECTING THE BAUD RATE FOR THE RS-232 INTERFACE	19
6.	CALIBRATION	21
6.1	CLOSED-BOX CALIBRATION	21
6.2	CALIBRATION SCHEDULE	21
6.3	BASIC CALIBRATION PROCESS	21
6.3.1	Initial Calibration Procedure	21
6.3.2	Torque Offset and Gain	22
6.3.3	Accessory Torque Offset and Gain	23
6.3.4	Auxiliary Input Offset and Gain	23
6.4	ALTERNATE CALIBRATION PROCEDURE	23
7.	TROUBLESHOOTING	26
	APPENDIX A: LABVIEW PROGRAMMING EXAMPLES	27
A.1	SIMPLE READ	27
A.2	CURRENT STABILIZED	28
	APPENDIX B: FRONT PANEL/DISPLAY MENU FLOW CHARTS	29
B.1	SETUP MENU	29
B.2	POWER UNITS MENU	30
B.3	AUX SETUP MENU	30
B.4	TORQUE UNITS MENU	31
	APPENDIX C: SCHEMATICS	32
C.1	ENCODER/SWITCH BOARD	32
C.2	POWER SUPPLY	32
C.3	DSP & MEMORY	33
C.4	ANALOG I/O	34
	SERVICE INFORMATION	35
RETURNING MAGTROL EQUIPMENT FOR REPAIR AND/OR CALIBRATION		35
Returning Equipment to Magtrol, Inc. (United States)		35
Returning Equipment to Magtrol SA (Switzerland)		35

TABLE OF FIGURES

2. CONTROLS.....	12
Figure 2-1 Front Panel	12
Figure 2-2 Secondary Function Menu	12
Figure 2-3 Rear Panel	14
Figure 2-4 Dynamometer Brake Output	14
Figure 2-5 Accessory Torque-Speed Output.....	14
Figure 2-6 Dynamometer/TSC1 Connector.....	15
Figure 2-7 RS-232C Interface.....	15
Figure 2-8 GPIB/IEEE-488 Interface	15
3. INSTALLATION	9
Figure 3-1 Cover for Voltage Selector, Fuses	9
5. COMPUTER CONTROLLED OPERATION	14
Figure 5-1 GPIB (IEEE-488) Interface.....	15
Figure 5-2 Connector Pin-Out	19
6. CALIBRATION	21
Figure 6-1 Alternative Calibration	24

Preface

PURPOSE OF THIS MANUAL

This manual contains all the information required for the installation and general use of the Model 6200 Open Loop Dynamometer Controller. To ensure proper use of the instrument, please read this manual thoroughly before operating it. Keep the manual in a safe place for quick reference whenever a question arises.

WHO SHOULD USE THIS MANUAL

This manual is intended for bench test operators who are going to use the Model 6200 Dynamometer Controller in conjunction with any Magtrol Hysteresis Dynamometer or auxiliary instrumentation.

MANUAL ORGANIZATION

This section gives an overview of the structure of the manual and the information contained within it. Some information has been deliberately repeated in different sections of the document to minimize cross-referencing and to facilitate understanding through reiteration.

The structure of the manual is as follows:

- Chapter 1: INTRODUCTION - Contains the technical data sheet for the 6200 Dynamometer Controller, which describes the unit and provides its technical characteristics.
- Chapter 2: CONTROLS - Description of the elements located on the front and rear panels of the unit.
- Chapter 3: INSTALLATION - Provides setup options available with the 6200 Dynamometer Controller. Illustrates and outlines the hardware connection setup and software configurations for each option.
- Chapter 4: MANUALLY CONTROLLED OPERATION - How to run a test when the 6200 is used as a stand-alone unit. Includes information on setting power and torque units, torque and speed control and open loop control.
- Chapter 5: COMPUTER CONTROLLED OPERATION - How to run a test when the 6200 is used with a PC. Includes information on GPIB Interface, RS-232 Interface, data format, programming and command set.
- Chapter 6: CALIBRATION - Provides recommended calibration schedules along with step-by-step instructions for the calibration procedure.
- Chapter 7: TROUBLESHOOTING - Solutions to common problems encountered during setup and testing.
- Appendix A: LABVIEW™ PROGRAMMING EXAMPLES - Magtrol's comprehensive motor-test software programs, made specifically to compliment the 6200 Dynamometer Controller.
- Appendix B: FRONT PANEL/DISPLAY MENU FLOW CHARTS - A visual display of various setup procedures.

Appendix C: SCHEMATICS - For Encoder/Switch Board, Power Supply, DSP & Memory and Analog I/O.

CONVENTIONS USED IN THIS MANUAL

The following symbols and type styles may be used in this manual to highlight certain parts of the text:



Note: This is intended to draw the operator's attention to complementary information or advice relating to the subject being treated. It introduces information enabling the correct and optimal functioning of the product to be obtained.



CAUTION: THIS IS USED TO DRAW THE OPERATOR'S ATTENTION TO INFORMATION, DIRECTIVES, PROCEDURES, ETC. WHICH, IF IGNORED, MAY RESULT IN DAMAGE BEING CAUSED TO THE MATERIAL BEING USED. THE ASSOCIATED TEXT DESCRIBES THE NECESSARY PRECAUTIONS TO TAKE AND THE CONSEQUENCES THAT MAY ARISE IF THE PRECAUTIONS ARE IGNORED.



WARNING! THIS INTRODUCES DIRECTIVES, PROCEDURES, PRECAUTIONARY MEASURES, ETC. WHICH MUST BE EXECUTED OR FOLLOWED WITH THE UTMOST CARE AND ATTENTION, OTHERWISE THE PERSONAL SAFETY OF THE OPERATOR OR THIRD PARTY MAY BE PUT AT RISK. THE READER MUST ABSOLUTELY TAKE NOTE OF THE ACCOMPANYING TEXT, AND ACT UPON IT, BEFORE PROCEEDING FURTHER.

1. Introduction

1.1 UNPACKING YOUR 6200

Your 6200 was packaged carefully for shipping. Please notify your carrier and Magtrol Customer Service if you believe your unit was damaged in shipping.

1. Save all shipping cartons and packaging material until you inspect the 6200.
2. Inspect the 6200 for any evidence of damage in shipping.
3. Make sure the carton contains the following:

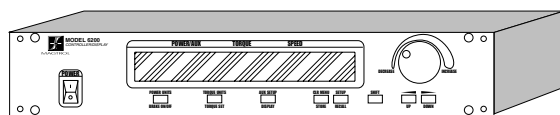

6200 Dynamometer Controller/Readout

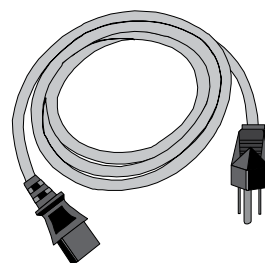

Line cord

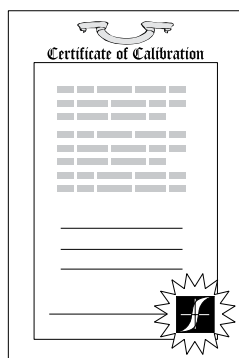

Calibration Certificate

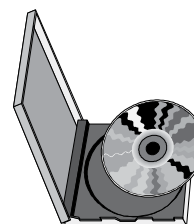

Magtrol User Manual CD-Rom

1.2 FEATURES OF THE 6200

- High quality, easy to read display - Vacuum fluorescent readout with 0.36" (9.1 mm) high digits.
- High-speed data acquisition - 120 torque and speed readings per second via IEEE (GPIB) bus.
- Pass/Fail testing - Upper and lower limits are programmable for torque, speed, and auxiliary input.
- Current regulated supply - Provides up to 1 amp output.
- Internal data storage - Nonvolatile memory of up to 100 data points.
- Dynamometer overload protection - Maximum power limit can be programmed to shut down if exceeded.
- Two standard computer interfaces - RS-232 and IEEE-488.
- Additional analog input - Accepts any ± 5 VDC transducer.
- Many torque measurement options - Includes English, metric, and SI torque readings as standard.
- Closed box calibration of torque and auxiliary input - Eliminates need to open box for adjustments.

The 6200 is designed to work with any personal computer using an IEEE-488 or an RS-232 interface, or as a stand-alone unit. In a computer-controlled environment, the 6200 provides the following motor testing capabilities:

- Current regulated control of dynamometer brake for open-loop testing
- Torque (Q) and Speed (N) data acquisition at a rate of up to 120 readings per second.
- Saving - Allows user to save programmed values within their configurations.

1.3 DATA SHEET

Model 6200 Open-Loop Dynamometer Controller

FEATURES

- Open-Loop Dynamometer Control
- Built-in Pass/Fail Motor Testing Capability
- Interfaces: RS-232 and IEEE-488
- High Speed Data Acquisition: 120 torque and speed points per second via IEEE bus (approx. 60/sec. via RS-232)
- High Quality, Easy-to-Read Vacuum Fluorescent Readout: Displays torque, speed, power and auxiliary values
- Current-Regulated Supply: Provides up to 1 amp output
- Adjustable Torque Units: English, Metric and SI are standard
- Dynamometer Overload Protection
- Internal Data Storage: Up to 100 data points
- Auxiliary ± 5 VDC Analog Input: For additional transducer
- Closed Box Calibration
- Rack Mounting: 19" (482.6 mm) with handles



and mechanical power values of the motor under test. In place of mechanical power, it can also display auxiliary transducer readings via the ± 5 VDC analog input. These displayed values can be stored internally or output via the RS-232 or IEEE-488 interface.

PASS/FAIL MOTOR TESTING

The Model 6200 comes with an easy-to-use motor testing Pass/Fail feature. This feature is ideal for quick pass/fail (go/no go) testing in production and incoming inspection applications.

When the 6200 is operated in the Pass/Fail mode, one of the readings is used as the tested parameter: torque, speed or the auxiliary transducer. The two parameters not used are set with user-defined upper and lower acceptable limits. As the motor is loaded to the tested parameter value (for example, speed) the other two parameters (in this case, torque and transducer) are measured. Test results (for the other 2 parameters) are indicated with a "PASS" or "FAIL", or the display can be toggled to show the actual values.

DESCRIPTION

Magtrol's Model 6200 is an Open-Loop Controller designed for use with any Magtrol Hysteresis Dynamometer. The unit provides open-loop control of the dynamometer via an internal current-regulated power supply. With a high-quality vacuum fluorescent readout, the Model 6200 displays torque, speed

SYSTEM CONFIGURATION

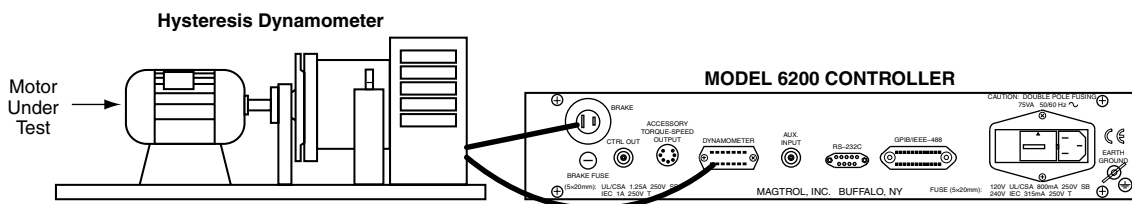

ORDERING INFORMATION

6200	Open Loop Dynamometer Controller	120 VAC
6200A	Open Loop Dynamometer Controller	240 VAC

Specifications

6200

MEASUREMENT CHARACTERISTICS	
Maximum Torque	2000 units
Maximum Speed	99,999 rpm
Accuracy	Speed: 0.01% of reading from 10 rpm to 100,000 rpm Torque: 0.2% of range (± 2 V) Aux: 0.1% of range (± 5 V)
ELECTRICAL CHARACTERISTICS	
Fuses (5 x 20 mm)	Brake: UL/CSA 1.25 A 250 V SB
	IEC 1.00 A 250 V T
	Power (120 V): UL/CSA 800 mA 250 V SB
	Power (240 V): IEC 315 mA 250 V T
Power Requirements	75 VA
Voltage Requirements	120/240 V 60/50 Hz
Max. Compliance Voltage	45 VDC
INPUTS AND OUTPUTS	
Auxiliary Input	± 5 VDC
Accessory Torque/Speed Output	Torque: ± 2 VDC Speed: 60 TTL pulses/rev, 50% duty cycle
Ctrl Out	0–3 VDC
ENVIRONMENT	
Operating Temperature	18 °C to 25 °C
Relative Humidity	< 80%
Temperature Coefficient	0.001% of range/°C

DIMENSIONS		
Width	19.0 in	483 mm
Height	3.5 in	89 mm
Depth	12.4 in	315 mm
with handles	13.8 in	351 mm
Weight	16.37 lb	7.42 kg

FRONT PANEL

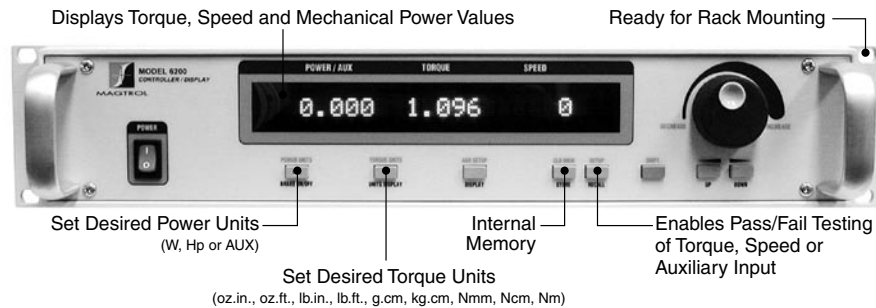

REAR PANEL

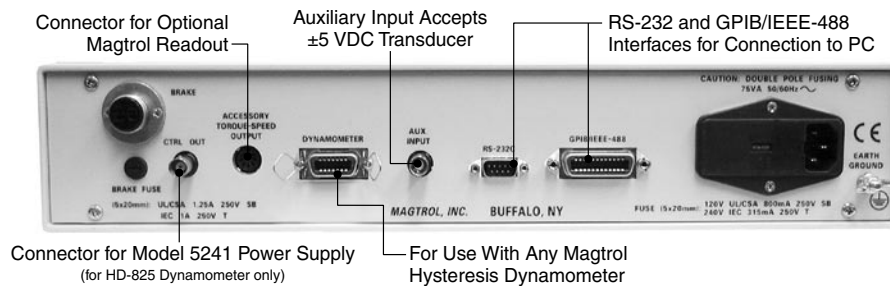

Due to the continual development of our products, we reserve the right to modify specifications without forewarning.

2. Controls

2.1 FRONT PANEL

The front panel provides a power switch, nine control buttons, a Decrease/Increase Dial, and Vacuum Fluorescent Display (VFD)

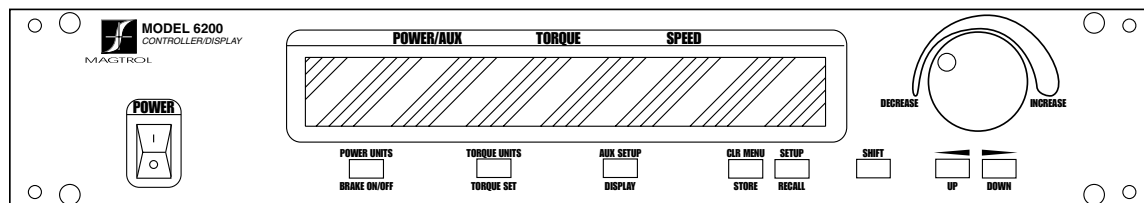

Figure 2-1 Front Panel

2.1.1 FRONT PANEL CONTROLS AND BUTTONS

The front panel controls and buttons, from left to right, are:

- Power switch
- Five double-function control button:

Primary Function	Secondary Function
BRAKE ON/OFF	POWER UNITS
UNITS DISPLAY	TORQUE UNITS
DISPLAY	AUX SETUP
STORE	CLR MEM
RECALL	SETUP

- Three single-function control buttons:
 - SHIFT (enables saving function and secondary functions printed in blue above control buttons)
 - UP - Left arrow ◀ (moves cursor to the left)
 - DOWN - Right arrow ▶ (moves cursor to the right)
- Decrease/Increase Dial (decreases or increases the selected parameter)

2.1.1.1 Enabling Secondary Functions

To enable the secondary function of the double-function control buttons:

1. Press the blue SHIFT button and release it. The word “SHIFT” appears in the display:

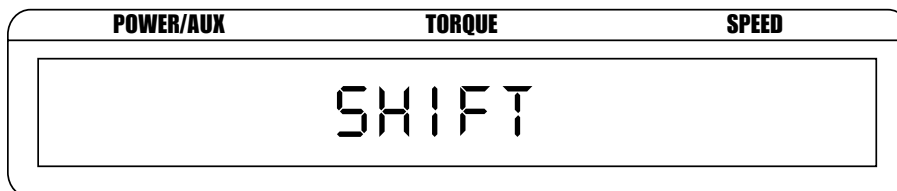

Figure 2-2 Secondary Function Menu

2. Press any control button to enable the function shown in blue letters above the button:

POWER UNITS, TORQUE UNITS, AUX SETUP, CLR MEM OR SETUP

3. Press the SHIFT button again to exit the secondary function and return to main menu.

2.1.2 HOW TO USE FRONT PANEL CONTROLS AND BUTTONS

2.1.2.1 Controls/Single-Function Buttons

Button	To Use	Function
POWER	Press I to turn power ON. Press O to turn power off.	Turns power ON or OFF.
SHIFT	Press this button and release; then press desired control button.	Enables the function written in blue above control button.
UP/LEFT	Press.	Increases magnitude of change when adjusting a numerical value (speed, torque or max. speed).
DOWN/RIGHT	Press.	Decreases magnitude of change when adjusting a numerical value (speed, torque or max. speed).
DECREASE/ INCREASE DIAL	Turn clockwise or counterclockwise.	Increases or decreases the parameter selected.

2.1.2.2 Double-Function Buttons

Button	To Use	Function
POWER UNITS	Press SHIFT and release; then press this button	Sets power display to WATTS, HP or AUX input.
BRAKE ON/OFF	Press.	Toggles brake ON or OFF.
TORQUE UNITS	Press SHIFT and release; then press this button	Enables you to set desired unit of measure. Press UP or DOWN button to see options. Press SHIFT to enable option.
UNITS DISPLAY	Press.	Shows power units, torque units and percent of full scale current output.
AUX SETUP	Press SHIFT and release; then press this button	Enables you to set the scaling of the auxiliary input.
DISPLAY	Press.	When in the PASS/FAIL mode, shows actual value of parameter.
CLR MEM	Press SHIFT and release; then press this button	Clears the data memory. Resets next memory location to 0.
STORE	Press.	Stores data into next available memory location.
SETUP	Press SHIFT and release; then press this button	Enables user to select SYSTEM, PASS/FAIL and I/O menus.
RECALL	Press.	Displays memory contents beginning at last stored value.

2.2 REAR PANEL

The rear panel provides connectors and receptacles for connecting to appropriate equipment. Refer to figures 3, 4 and 5 in this chapter for detailed drawings of the brake

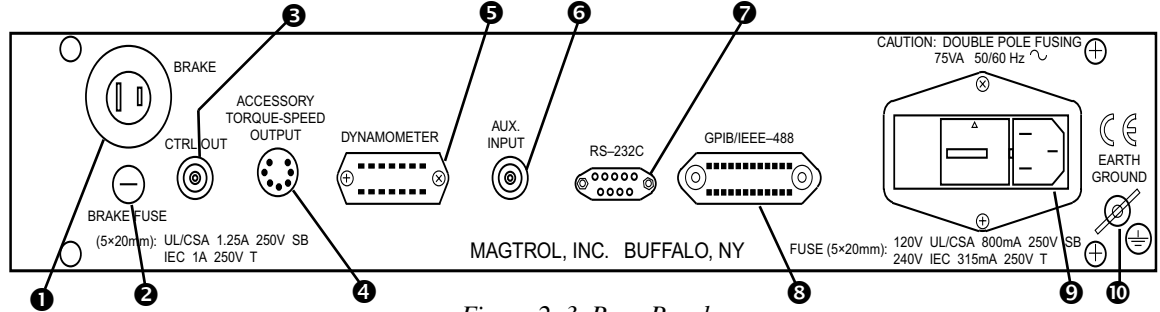

Figure 2-3 Rear Panel

2.2.1 REAR PANEL FUNCTIONS

The rear panel, from left to right, provides the following functions:

- ❶ BRAKE Connect dynamometer brake cable here.

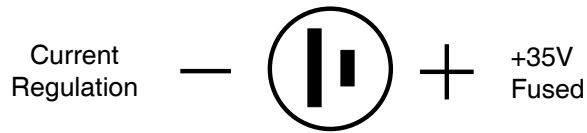
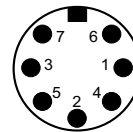

Figure 2-4 Dynamometer Brake Output

- ❷ BRAKE FUSE Contains brake fuse (5 x 20 mm)
(UL/CSA 1.25A 250V SB)
(IEC 1A 250V T)
- ❸ CTRL OUT Connect to Model 5241 Power Amplifier when using HD-825 Dynamometer.

- ❹ ACCESSORY TORQUE/SPEED OUTPUT Connect accessory output cable here (optional).



- 1. TACH. SIGNAL
- 2. TORQUE OUTPUT
- 3. D.P.
- 4. TORQUE COMMON
- 5. N/C
- 6. TACH. COMMON
- 7. D.P.

Figure 2-5 Accessory Torque-Speed Output



CAUTION: FOR USE WITH MAGTROL READOUTS ONLY. CONNECTING ANOTHER DEVICE TO THIS OUTPUT MAY CAUSE EQUIPMENT FAILURE.

5 DYNAMOMETER Connect dynamometer signal cable here.

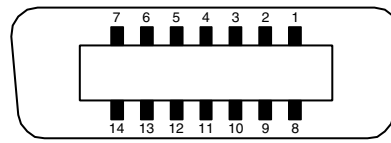

- | | |
|---------------------|-------------------|
| 1. N/C | 8. COMMON |
| 2. N/C | 9. D.P. |
| 3. ISOLATED +22 VDC | 10. TACH. SIGNAL |
| 4. ISOLATED -22 VDC | 11. N/C |
| 5. ISOLATED +22 VDC | 12. D.P. |
| 6. ISOLATED -22 VDC | 13. TORQUE COMMON |
| 7. TACH. +5.0 VDC | 14. TORQUE SIGNAL |

Figure 2–6 Dynamometer/TSC1 Connector

6 AUX INPUT Connect auxiliary instrument signal cable here.

7 RS-232C Use this socket for RS-232 connector cable

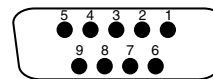

- 1.
- 2. TX
- 3. RX
- 4.
- 5. GND
- 6.
- 7.
- 8.
- 9. N/C

Figure 2–7 RS-232C Interface

8 GPIB/IEEE-488 Use this socket for GPIB cable (meets IEEE-488 specifications).

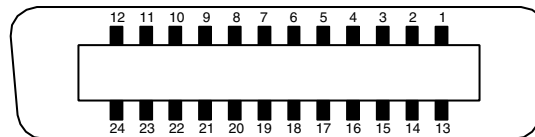

- | | |
|------------|-------------------|
| 1. D1 | 13. D5 |
| 2. D2 | 14. D6 |
| 3. D3 | 15. D7 |
| 4. D4 | 16. D8 |
| 5. E01 | 17. REN |
| 6. DAV | 18. DAV-COM |
| 7. NRFD | 19. NRFD-COM |
| 8. NDAC | 20. NDAC-COM |
| 9. IFC | 21. IFC-COM |
| 10. SRQ | 22. SRQ-COM |
| 11. ATN | 23. ATN-COM |
| 12. SHIELD | 24. SIGNAL GROUND |

Figure 2–8 GPIB/IEEE-488 Interface

9 POWER Attach power cord here.

10 EARTH GROUND Attach earth ground here.

2.3 VACUUM FLUORESCENT DISPLAY (VFD)

The VFD provides information about the control functions, the motor under test, and an auxiliary input device (if connected). The displays, from left to right, are:

- POWER (expressed in horsepower or watts)/AUX INPUT
- TORQUE
- SPEED
- Memory Indicator

2.3.1 CONTRAST SETTINGS

The 6200 is shipped with the Contrast Setting at zero (lowest) in order to prolong display life. If it is necessary to increase the Contrast for improved readability, execute the following steps:

1. Press SHIFT.
2. Press COM SETUP button.
3. Select CONTRAST until desired brightness is reached.
4. Press SHIFT to return to main menu.

Note: Make sure the lowest possible setting is used to achieve desired result. Using a setting higher than necessary may cause display segments to burn-in over a period of time, resulting in uneven illumination from segment to segment.

2.3.2 DISPLAYING DESIRED INFORMATION

2.3.2.1 Local Control

1. Press SHIFT and release; then press POWER UNITS to see UNITS displayed.
2. Press UP ◀ or DOWN ▶ to scroll through available choices.
3. Press SHIFT to exit.
4. Press SHIFT and release; then press TORQUE UNITS to see UNITS displayed.
5. Press UP ◀ or DOWN ▶ to scroll through options for units.
6. Press SHIFT to exit.
7. Press RECALL to view memory contents; last in = first out.
8. Press SHIFT to exit.

2.3.2.2 Remote Control

Refer to “6200 Command Set” in Chapter 4 - The 6200 with a PC for a list of commands recognized by the 6200.

2.3.2.3 Auxiliary Input

1. Press SHIFT and release; then press AUX SETUP.
2. Rotate Decrease/Increase Dial to select scale.
3. Press SHIFT to exit.

3. Installation



Note: Before installing the 6200, you should become familiar with the front and rear panels, as outlined in *Chapter 2—Controls*.

3.1 POWERING UP THE 6200



WARNING! TO REDUCE THE RISK OF ELECTRIC SHOCK, MAKE SURE THE 6200 IS EARTH GROUNDED BEFORE STARTING!

3.1.1 SETTING UNIT FOR LINE VOLTAGE

The 6200 will operate with either of the following power sources:

- 120 V 50/60 Hz
- 240 V 50/60 Hz

1. Find the line cord receptacle on rear panel. The line cord is a detachable NEMA Standard 3 wire.
2. Make sure the selector matches the power source (numbers should match the line voltage).

If not:

- Locate the power entry module.
- Remove the line cord.
- Insert a screwdriver into the slot and open the cover.
- Slide the voltage selector so the desired line voltage appears in the window.
- Install the appropriate fuses for that voltage.

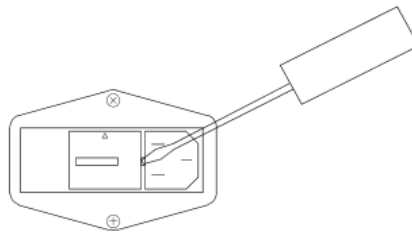

Figure 3–1 Cover for Voltage Selector, Fuses

3.1.2 HARDWARE CONNECTION

Do not overload or stall the motor. Prolonged overload can cause the motor to overheat.



Note: To make sure that the 6200 is operational, a Magtrol dynamometer with a test motor installed must be connected to the 6200. It is not required that the 6200 be connected to a computer.

1. Connect the 6200 to the dynamometer using the following cables:
 - 14-pin signal cable
 - 2-pin brake power cable
2. Turn on 6200 power.

3.1.3 SELF-TEST

After turning the power on to the 6200, the display panel will show all segments of the VFD (series of rectangles), indicating that the 6200 is downloading the program.

When the program download is complete, the message “MAGTROL 6200” appears.

3.2 BASIC TEST SETUP

1. After the Model Display wappears, press the UNITS DISPLAY button and set current output to 0% with Decrease/Increase Dial.
2. Start the test motor.
3. Allow the motor speed to stabilize at its no-load speed for a few seconds.
4. Press the BRAKE ON/OFF button to ON.
5. Turn the Decrease/Increase Dial clockwise.

Desired results:

- The torque reading will increase.

As brake power is applied, load is applied to the motor. The applied torque increases as the Decrease/Increase Dial is turned clockwise. For most motors, loading is indicated by motor speed reduction.

8. Reduce the torque load to zero by turning the Decrease/Increase Dial counterclockwise.

Desired results:

- The torque reading will decrease.

9. Press the BRAKE ON/OFF Button to OFF.
10. Turn off power to the test motor.



Note: If the desired results did not occur, please see Chapter 7 – Troubleshooting.

4. Manually Controlled Operation

4.1 SETTING DESIRED OPERATING PARAMETERS



Note: See Appendix B: Front Panel/Display Menu Flow Charts.

4.1.1 SET POWER DISPLAY TO DESIRED UNITS (WATTS, HP OR AUX.)

1. Press and release SHIFT.
2. Press POWER UNITS.
3. Press UP ◀ or DOWN ▶ to scroll through choices.
4. Press SHIFT to exit.

4.1.2 SET DISPLAY TO DESIRED TORQUE UNITS

1. Press and release SHIFT.
2. Press TORQUE UNITS.
3. Press UP ◀ or DOWN ▶ until you see the desired unit of measure.
4. Press SHIFT to exit.

4.1.3 SET UP SYSTEM PARAMETERS

1. Press and release SHIFT.
2. Press SETUP.
3. Press SHIFT.
4. Press UP ◀ or DOWN ▶ until you see the desired unit of input torque.
5. Press SHIFT.
6. Press UP ◀ or DOWN ▶ until selection matches encoder installed on dynamometer. (60-bit = standard)
7. Press SHIFT.
8. Use the UP ◀ or DOWN ▶ buttons and the Decrease/Increase Dial to adjust the maximum power setpoint for the dynamometer in use.
9. Press SHIFT to exit.

4.1.4 SET UP PASS/FAIL PARAMETERS

1. Press and release SHIFT.
2. Press SETUP.
3. Press the DOWN ▶ button once.
4. Press SHIFT.
5. Press UP ◀ or DOWN ▶ to turn ON or OFF Torque PASS/FAIL testing.
6. If ON, press SHIFT.
7. Use the ◀ or DOWN ▶ buttons and the Decrease/Increase Dial to adjust the high limit for Torque.
8. Press SHIFT.
9. Use the ◀ or DOWN ▶ buttons and the Decrease/Increase Dial to adjust the low limit for Torque.

10. Press SHIFT.
11. Press UP ◀ or DOWN ▶ to turn ON or OFF Speed PASS/FAIL testing.
12. If ON, press SHIFT.
13. Use the UP ◀ or DOWN ▶ buttons and the Decrease/Increase Dial to adjust the high limit for Speed.
14. Press SHIFT.
15. Use the UP ◀ or DOWN ▶ buttons and the Decrease/Increase Dial to adjust the low limit for Speed.
16. Press SHIFT.
17. Press UP ◀ or DOWN ▶ to turn ON or OFF Auxiliary Input PASS/FAIL testing.
18. If ON, press SHIFT.
19. Use the UP ◀ or DOWN ▶ buttons and the Decrease/Increase Dial to adjust the high limit for Auxiliary Input.
20. Press SHIFT.
21. Use the UP ◀ or DOWN ▶ buttons and the Decrease/Increase Dial to adjust the low limit for Auxiliary Input.
22. Press SHIFT to exit.

4.1.5 SET UP I/O PARAMETERS

1. Press and release SHIFT.
2. Press SETUP.
3. Press the DOWN ▶ button twice.
4. Press SHIFT.
5. Press UP ◀ or DOWN ▶ until you see the desired contrast level.
6. Press SHIFT.
7. Press UP ◀ or DOWN ▶ until you see the desired GPIB address.
8. Press SHIFT.
9. Press UP ◀ or DOWN ▶ until you see the desired RS-232 baud rate.
10. Press SHIFT to exit.

4.2 SETTING DYNAMOMETER LOAD

1. Press the UNITS DISPLAY button.
2. Use the Decrease/Increase Dial to adjust the current output to 0%.
3. Use the BRAKE ON/OFF button to turn the brake ON.
4. Start the motor under test.
5. Use the UP ◀ or DOWN ▶ buttons and the Decrease/Increase Dial to adjust the loading on the motor.



CAUTION: DO NOT EXCEED THE CAPABILITIES OF THE DYNAMOMETER OR THE POWER SOURCE IN USE. MOTORS DRAW VERY LARGE CURRENTS WHEN HELD AT LOCKED ROTOR, AND OVERHEATING MAY RESULT. WHEN USING OPEN LOOP CURRENT CONTROL, INDUCTION MOTORS CANNOT BE TESTED BEYOND BREAKDOWN, EXCEPT AT LOCKED ROTOR.

4.3 USING INTERNAL MEMORY

4.3.1 STORING DATA POINTS

1. Press and release STORE. The VFD will indicate STORE followed by a number. This indicates the memory location that contains the data.
2. Continue pressing STORE at each desired point.

4.3.2 RECALLING DATA POINTS

1. Press and release RECALL. The VFD will indicate RECALL followed by a number. This number indicates the memory location that is being displayed. The order of recalled data is LAST IN = FIRST OUT (LIFO). A “M” also appears to the right of the SPEED display to let the user know that the displayed data is from memory and not real time data.
2. Continue pressing RECALL until all the desired data is retrieved. Once data has been recalled, it is lost from internal memory.

4.3.3 EXITING THE MEMORY MODE

1. Press and release SHIFT.

4.3.4 CLEARING THE MEMORY

1. Press and release SHIFT.
2. Then press CLR MEM.

5. Computer Controlled Operation

The 6200 can be used with a personal computer to control a dynamometer and to transmit data from motor testing directly to the computer.

5.1 ABOUT THE GPIB INTERFACE

Magtrol instruments use the GPIB (IEEE-488 Standard) for computer-to-instrument interfacing because:

- The GPIB parallel interface is faster than serial interfaces.
- The GPIB enables testers to access up to 15 instruments on one port. Because typical motor testing requires that at least five separate parameters must be synchronized, a system of easy, fast access to more than one instrument is essential.
- The GPIB has rigid data formatting and hardware standards. These standards help to ensure that all functions will work properly when the hardware and software are installed.



Note: The GPIB interface is not standard on most computers. An interface card and driver software must be installed. Magtrol recommends National Instruments Corporation hardware and software.

- An IEEE-488 cable must be installed between the computer and the 6200.

5.1.1 INSTALLING THE GPIB (IEEE-488) CONNECTOR CABLE



CAUTION: MAKE SURE BOTH THE COMPUTER AND THE 6200 ARE TURNED OFF BEFORE INSTALLING THE GPIB CONNECTOR CABLE.

1. Connect one end of a high-quality, double-shielded cable to the 6200 GPIB connector.
2. Connect the other end to the GPIB interface in your PC.

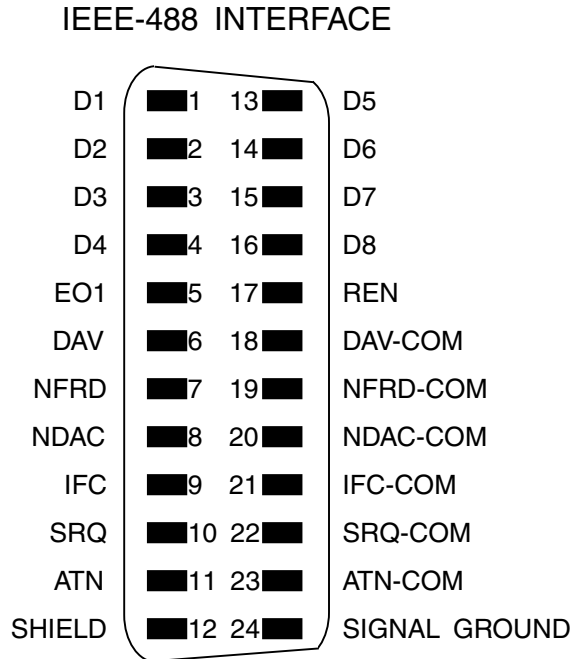

Figure 5-1 GPIB (IEEE-488) Interface

5.1.2 CHANGING THE GPIB PRIMARY ADDRESS

Each instrument serviced by the GPIB has its own Primary Address code, which enables the computer to obtain readings from the instrument. The factory default setting on the 6200 is 15.

Some PC interfaces can access from one to fifteen 4-bit primary addresses. Other interfaces can access as many as thirty-one 5-bit primary addresses. The 6200 uses the 4-bit format.

1. Press the SHIFT button and release.
2. Press SETUP.
3. Press DOWN ► twice.
4. Press SHIFT twice.
5. Press ◀ or DOWN ► until you see the desired GPIB address.
6. Press SHIFT twice to exit.

5.2 CHECKING THE 6200-TO-PC CONNECTION



Note: Make sure that the 6200 and its host computer are communicating before acquiring data.

1. Make sure the primary address is set correctly for the 6200.
2. Set the input variable to 15 characters (13 variable characters and the two required data termination characters CR and LF. (See “Programming” in this chapter.)
3. Issue output data command “OD” and read 15 characters according to the instructions for your GPIB interface.

Desired results:

- Torque/speed data will be returned



Note: If the desired results did not occur, Please see *Chapter 7 - Troubleshooting*.

5.3 PROGRAMMING



Note: Check the manual provided with your software for full instructions.

1. Use the following information to answer the formatting questions asked when installing your GPIB software.
 - All GPIB data acquisition systems requires the use of data termination characters. The 6200 uses the GPIB standard termination characters “Carriage Return (CR)-Line Feed (LF).” Provide them in that order.

Codes for CR - LF

	BASIC	HEX	DEC
CR =	CHR\$(13)	0D	13
LF =	CHR\$(10)	0A	10

2. Set the timeout for at least one second, if you are asked to set a communication fault delay timeout.
 - If the communication fault delay timeout is too short, or if the computer resets the interface too quickly, the host instrument may stop responding.

5.4 6200 COMMAND SET

When entering a command code:

1. Type all characters in uppercase ASCII format.
2. End all commands with a CR-LF (hex 0D-0A).
3. Do not string multiple commands together in one line.

The character # represents a floating point numerical value following the command. Leading zeroes are not required.

5.4.1 COMMAND SET FOR 6200

Command Category	Command Code	Function	Explanation
Communications	H	Sets high data acquisitionrate (120 samples per second)	The Controller/Readout outputs data at 120 S/s (Using an RS-232 interface, the rate is 60 S/s.)
Communications	L	Sets low data acquisition rate (3.8 samples per second)	The Controller/Readout outputs data at 3.8 S/s (default rate).

Command Category	Command Code	Function	Explanation
Communications	OA	Prompts to return to auxiliary input data string	“Output Auxiliary” prompt to return the value at the AUX INPUT x AUX SCALING factor.
Communications	OD	Prompts to return speedtorque-direction data string	“Output Data” prompt to return data string with this format: SxxxxTxxxxRcrLf or SxxxxTxxxxLcrLf R or L is the shaft direction indicator, as viewed looking at the dynamometer shaft, where: R = right; clockwise (CW) L = left; counterclockwise (CCW) The speed will equal the displayed value and the torque will be in the same units as displayed on the front panel.
Setup	M1	Enables front panel controls	Use this command to enable front panel control of most functions.
Setup	M0	Locks out front panel controls	Use this command to lock out the front panel controls, so that the Controller/Readout settings can be changed only by using the computer with either the GPIB (IEEE-488) or the RS-232 interface. NOTE: The brake ON/OFF switch on the front panel still functions.
Setup	R	Resets as follows: • Manual control ON • Low data acquisition rate • Brake OFF	Use this command to cancel any previous commands. NOTE: These settings are the power-on default settings.
Setup	UA#	Sets auxiliary input scaling to #	This command sets the scaling factor for the auxiliary input to # units/volt. The range is 0.0 to 10000.0. Programmed value # is not saved at power down.
Setup	UE#	Sets encoder pulse count to #	This command selects the pulse count option for speed transducing. The pulse count defaults to 60-bit if out of range. The standard encoder supplied with all Magtrol Load Cell Dynamometers is 60 pulses/revolution. Optional 600 and 6000 pulse encoders are available for low-speed applications. Codes for pulse count # are: 0 = 60-bit 1 = 600-bit 2 = 6000-bit Programmed value # is not saved at power down.

Command Category	Command Code	Function	Explanation
Setup	UI#	Sets dynamometer torque units to #	NOTE: For Hp and watts calculations to be correct, the correct dynamometer torque units must be specified. Values for # are: 0 = oz.in. 5 = kg.cm. 1 = oz.ft. 6 = N.mm. 2 = lb.in. 7 = N.cm. 3 = lb.ft. 8 = N.m. 4 = g.cm. Torque units default to 0 (oz.in.) if out of range. Programmed value # is not saved at power down.
Setup	UR#	Sets readout torque units to #	This command sets the torque unit conversion for the torque readout. Values for # are: 0 = oz.in. 5 = kg.cm. 1 = oz.ft. 6 = N.mm. 2 = lb.in. 7 = N.cm. 3 = lb.ft. 8 = N.m. 4 = g.cm. Torque unit conversion defaults to 0 (oz.in.) if out of range. Programmed value # is not saved at power down.
Misc.	X	Prompts to return % current output	This command returns the % current value in the format "I##.##". The value will be between 0 (no loading) and 99.99 (full loading).
Misc.	I#	Sets current output to #	The power supply outputs a fixed value of current. Use any value # between 0 and 99.99%. (99.99% = 1 Amp.)

5.5 ACQUIRING SPEED-TORQUE DATA

Speed-torque data is a fixed-length string in ASCII format with a floating point decimal. Use the following string format:

SdddddTddd.R[cr][lf]

or

SdddddTddd.L[cr][lf]

where . . .

S = speed in RPM. No leading zeroes are used.

d = decimal digit 0 through 9

T = torque in units selected during setup. The torque value always contains a decimal point.

L = counterclockwise dynamometer shaft rotation (left)

R = clockwise dynamometer shaft rotation (right)

. = decimal point. The decimal point location depends on the specific dynamometer and torque range in use.



Note: The [cr] and [lf] characters will not display.

Example:

If a motor is running at 1725 RPM clockwise, with the dynamometer loading the motor to 22.6 oz.in., the 6200 will return:

S 1725T22.60R

By manipulating the string, the speed-torque and shaft direction (if required) can be extracted. Then separate numerical variables can be assigned to them for data processing.

5.6 SELECTING THE BAUD RATE FOR THE RS-232 INTERFACE

The 6200 communicates with the host computer through a DB-9 interface connector. The connector pin-out is:

2-RX, 3-TX, 4-DTR, 5-GND. No other pins are connected.

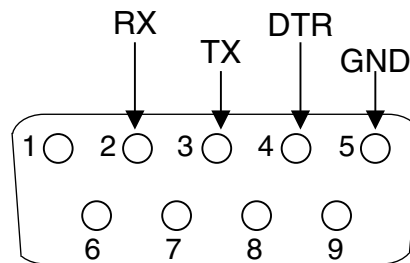

Figure 5-2 Connector Pin-Out

The 6200 is equipped with an RS-232 (serial) interface. To select the baud rate:

1. Press SHIFT and release.
2. Press SETUP button.
3. Press DOWN ► twice.
4. Press SHIFT three times.
5. Press the UP ◀ or DOWN ► buttons to cycle through the following available baud rates:

300	2400	9600
600	4800	19200
1200		
6. Press SHIFT to Exit

Other important communication parameters are:

- No Parity
- 8 Data Bits
- 1 Stop Bit

To wire your own serial communications cable, use the following wiring diagram:

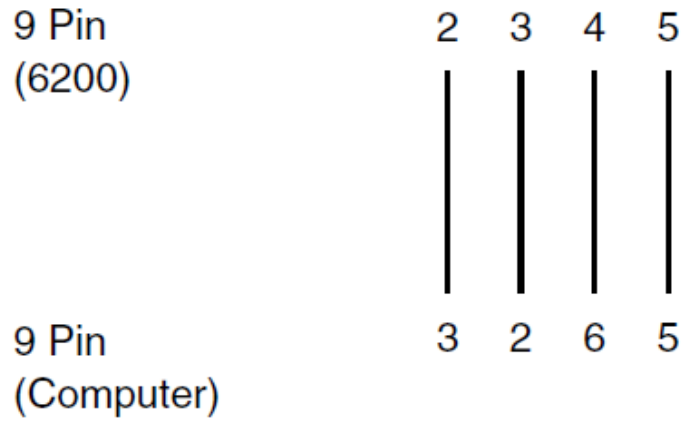

A cable may also be purchased from your local electronics store. A Radio Shack #26-152 cable and #26-264 null modem adapter are known to work. The null modem adapter must be used on the computer end of the cable.

OPERATION

6. Calibration

6.1 CLOSED-BOX CALIBRATION

The 6200 features closed-box calibration. The advantage of closed-box calibration is that the user does not have to disassemble the case or make mechanical adjustments. However, the calibration of the Accessory Torque Output must be done internally with Offset and Gain trim pots.

The Torque readout and Auxiliary Input can be calibrated using external reference sources. Correction factors for Offset and Gain are stored in nonvolatile memory. They remain in effect until the user or the calibration house updates them.

The front panel displays the actual values for the ZERO and GAIN correction factors. Record these values before calibration. In the unlikely event of a Controller/Readout failure, it can re-initialized by pressing and holding the STORE and RECALL buttons while turning the power on. All internal memory and setups will be lost. After re-initializing, reprogram the GAIN and ZERO values into memory.

6.2 CALIBRATION SCHEDULE

Calibrate the 6200:

- After any repairs are performed.
- At least once a year; more frequently to ensure required accuracy.

6.3 BASIC CALIBRATION PROCESS

The basic calibration process consists of four procedures which must be performed in the following order:

1. Initial Calibration Procedure
2. Torque Offset and Gain
3. Speed Verification
4. Accessory Torque Output Offset and Gain
5. Auxiliary Input Offset and Gain

Items needed for calibrating the 6200:

- External voltage reference of 0 to 5 volts DC
- Digital multimeter (DMM)
- Function generator with square wave, TTL output

Both instruments should have a VDC accuracy of 0.05% or better.

6.3.1 INITIAL CALIBRATION PROCEDURE



Note: Record the actual correction factors displayed before proceeding with calibration.

1. Allow the 6200 to stabilize in an environment with:
 - An ambient temperature of 18°C to 25°C.
 - Relative humidity less than 80%.
2. Turn on the 6200.
3. Allow the 6200 to warm up for at least 30 minutes.
4. Enable the calibration mode as follows:
 - a. Turn instrument power OFF.
 - b. Press in and hold the UP ◀ and DOWN ▶ buttons simultaneously.
 - c. Turn instrument power ON.
 - d. Continue pressing the UP ◀ and DOWN ▶ buttons until the display shows the software revision date then release.
 - e. Press the SHIFT button once.



Note: To exit CALIBRATE mode without making any changes, press the SHIFT button 6 times.

6.3.2 TORQUE OFFSET AND GAIN

1. Connect the external voltage reference common to Pin 13 and Pin 4 of the dynamometer input connector.
2. Connect the external voltage reference high to Pin 14 of the dynamometer input connector.
3. Apply +2.000 VDC.
4. Press the DISPLAY button.
5. Adjust the gain by turning the Decrease/Increase Dial until the displayed voltage equals the reference voltage.



Note: The magnitude of change per revolution can be increased by pressing the UP ◀ button or decreased by pressing the DOWN ▶ button.

6. Apply 0.000 VDC.
7. Press the UNITS DISPLAY button.
8. Adjust the Decrease/Increase Dial until the display indicates 0 mVDC.
9. Repeat steps 3 through 8 to complete this procedure.
10. Press SHIFT.
11. Record the T-ZERO correction factor for future reference.
12. Press SHIFT.
13. Record the T-GAIN correction factor for future reference.
14. Speed Verification:
 - a. Connect the function generator output to Pin 10 of the dynamometer input connector.
 - b. Connect the function generator common to Pin 8 of the dynamometer input connector.
 - c. Apply a square wave, TTL signal of 1000 Hz.
 - d. Verify the 6200 Speed readout displays 1000 +/- 0.01% of applied frequency.
 - e. Apply several additional frequencies (10 kHz, 50 kHz) and verify the Speed readout displays the applied frequency +/- 0.01%.

6.3.3 ACCESSORY TORQUE OFFSET AND GAIN

1. Connect the DMM common to Pin 4 of the Accessory Torque-Speed Output connector.
2. Connect the DMM high to Pin 2 of the Accessory Torque-Speed Output connector
3. Apply 0.000 VDC
4. Adjust R24 (OFFSET) on the circuit board for 0 mVDC on the DMM.
5. Apply +2.000 VDC.
6. Adjust R25 (GAIN) on the circuit board for +2.000 VDC on the DMM.

6.3.4 AUXILIARY INPUT OFFSET AND GAIN

1. Press SHIFT button once. Display indicates AUX INPUT calibration as follows:
2. Connect the external voltage reference to the Auxiliary Input BNC connector.
3. Apply +5.000 VDC.
4. Press DISPLAY button.
5. Adjust the gain by turning the Decrease/Increase Dial until the displayed voltage equals the reference voltage.



Note: The magnitude of change per revolution can be increased by pressing the UP ◀ button or decreased by pressing the DOWN ▶ button.

6. Apply 0.000 VDC.
7. Press UNITS DISPLAY button.
8. Adjust the Decrease/Increase Dial until the display indicates 0 mVDC.
9. Repeat steps 3 through 8 to complete this procedure.
10. Press SHIFT.
11. Record the A_ZERO correction factor for future reference.
12. Press SHIFT.
13. Record the A_GAIN correction factor for future reference.
14. Press the SHIFT button once to return to default display.

6.4 ALTERNATE CALIBRATION PROCEDURE

The 6200 can also be calibrated by using a certified dynamometer, calibration beam, and weight instead of an external voltage reference.



Note: Magtrol suggests you do NOT use this method. By using the alternate calibration procedure, you are calibrating the 6200 to a specific dynamometer, not to a reference standard. If you connect the 6200 to a different dynamometer, the resulting torque reading may be incorrect.

1. Connect the chosen dynamometer to the 6200 using the 14-pin signal cable and the 2-pin brake cable.
2. Attach the calibration beam to the dynamometer shaft.
3. Enter the calibration mode.
4. Press the BRAKE ON/OFF button ON to apply full loading to the dynamometer.
5. Hang the weight on the calibration beam pin and level the beam as illustrated in the following

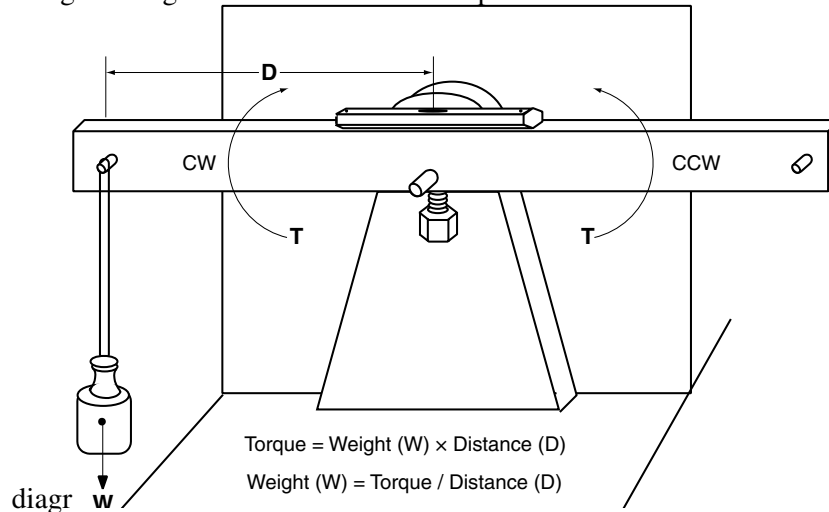

Figure 6–1 Alternative Calibration

6. Press the DISPLAY button.
7. Adjust the gain by turning the Decrease/Increase Dial until the displayed voltage equals the reference voltage.



Note: The magnitude of change per revolution can be increased by pressing the UP ◀ button or decreased by pressing the DOWN ▶ button.

8. Remove the weight for ZERO adjustment.
9. Press the UNITS DISPLAY button.
10. Adjust the Increase/Decrease Dial until the display indicates 0 mVDC.



Note: The mV output of the dynamometer will be equivalent to the Weight times Distance on the calibration beam, disregarding any decimal point.

Example

Magtrol's HD-400-6 Dynamometer has a full-scale torque of 40.0 oz-in. The distance from the center of the dynamometer shaft to the pin on the calibration beam is 5 inches. Placing an 8 oz. weight on the pin will produce a torque of 40.0 oz-in. The mV output of the dynamometer will be equivalent to 8 oz. multiplied by 5 inches, yielding an output signal of 400 mV.

11. Repeat steps 5 through 10.
12. After completing calibration, press BRAKE ON/OFF button OFF to remove loading from the dynamometer.
13. Remove the calibration beam from the dynamometer shaft.
14. Proceed with desired motor testing.

7. Troubleshooting

Problem	Reason	Solution
Mechanical power reads much higher or lower than expected.	Torque units are incorrect.	Set torque input units to match the specifications on dynamometer nameplate.
No GPIB communication.	Setup error and/or hardware fault.	Check: <ul style="list-style-type: none"> • GPIB address of Controller. • GPIB cable - should be functioning and attached to Controller and computer interface card.
No RS-232 communication.	Setup error and/or hardware fault.	Check: <ul style="list-style-type: none"> • Baud rate of Controller. • Pinout of serial cable. • Cable attachment to Controller and serial interface port of computer.
Dynamometer shaft does not turn smoothly when BRAKE is OFF.	Salient poles were set up on the rotor by having brake current applied with no shaft rotation.	Start the motor and bring up to speed. Press BRAKE button ON. Adjust output current up to a value at least 25% of the maximum torque rating of the dynamometer in use (if possible). Reduce output current to 0.

If you require additional assistance, please contact Magtrol Customer Service at 1-716-668-5555.

Appendix A: LabVIEW Programming Examples

Magtrol offers a comprehensive motor testing software program to satisfy most of your programming needs. To order your software, call Magtrol Sales at 1-716-668-5555.

A.1 SIMPLE READ

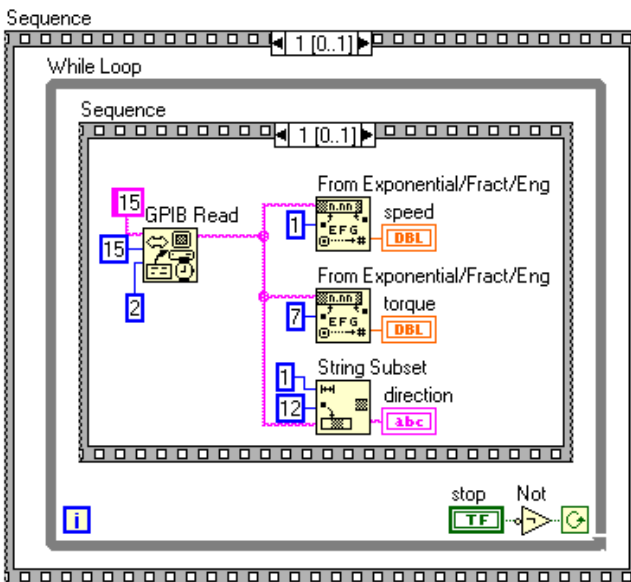
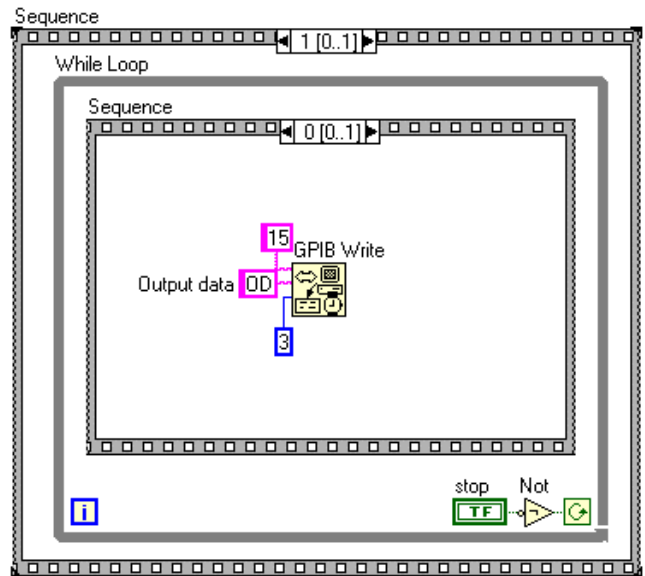
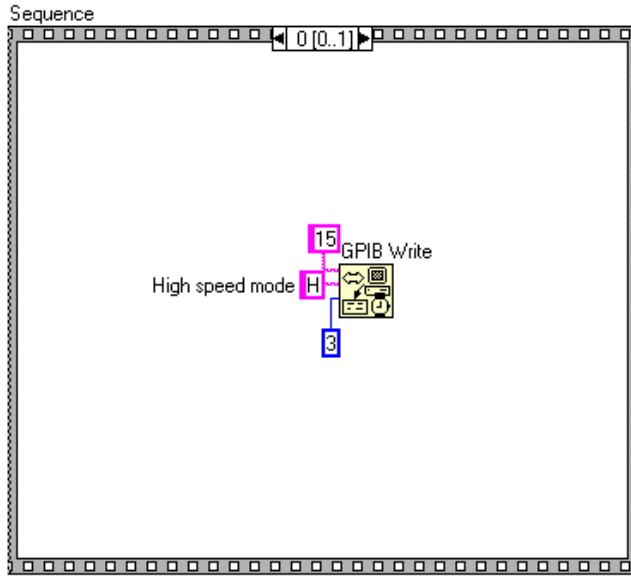

A.2 CURRENT STABILIZED

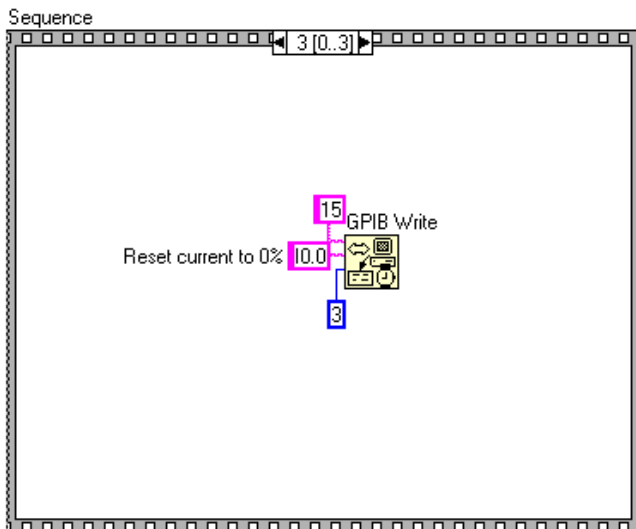
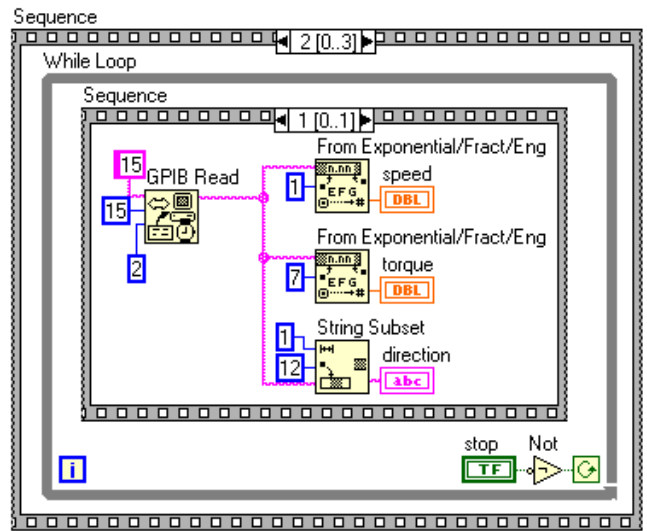
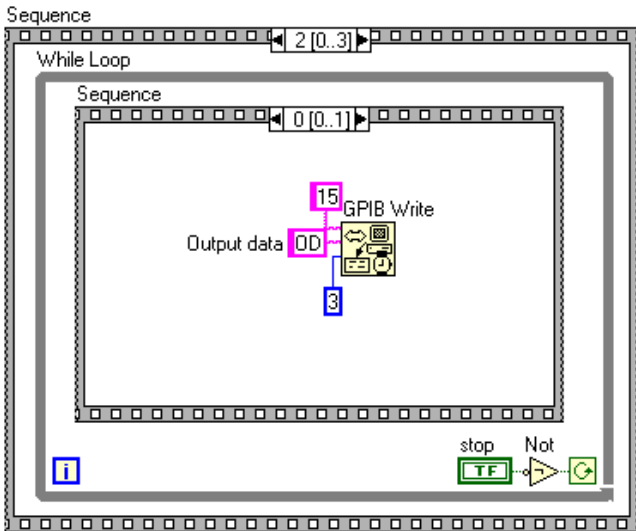
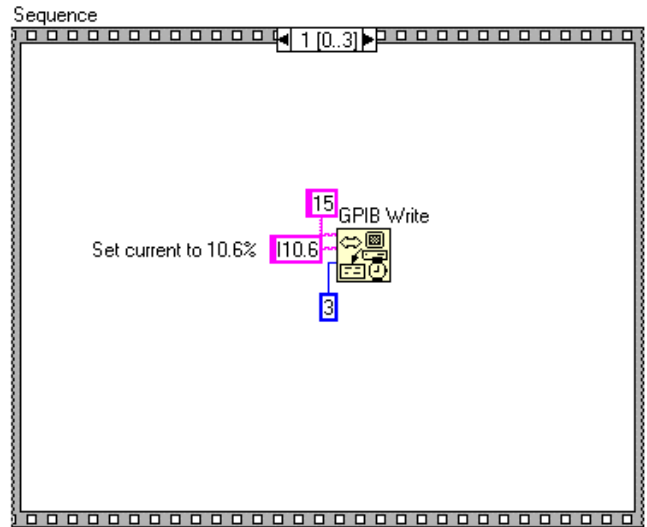
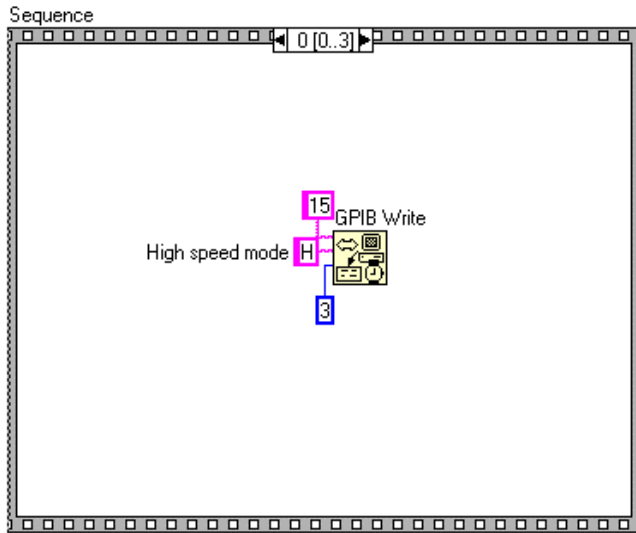

Appendix B: Front Panel/Display Menu Flow Charts

The following flow charts are a reference for navigating through the key setup functions of the 6200 Open Loop Dynamometer Controller. For step-by-step setup instructions, refer to the corresponding chapters in this manual.

B.1 SETUP MENU



B.2 POWER UNITS MENU

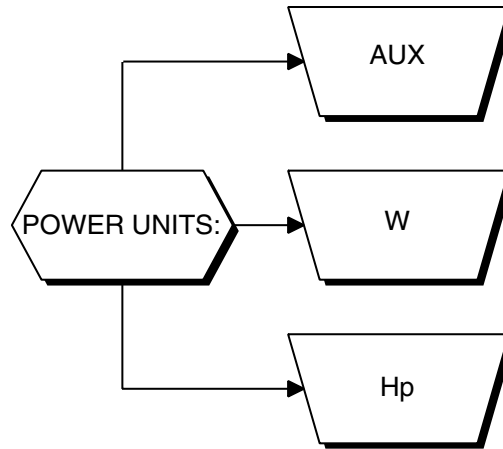

B.3 AUX SETUP MENU



B.4 TORQUE UNITS MENU

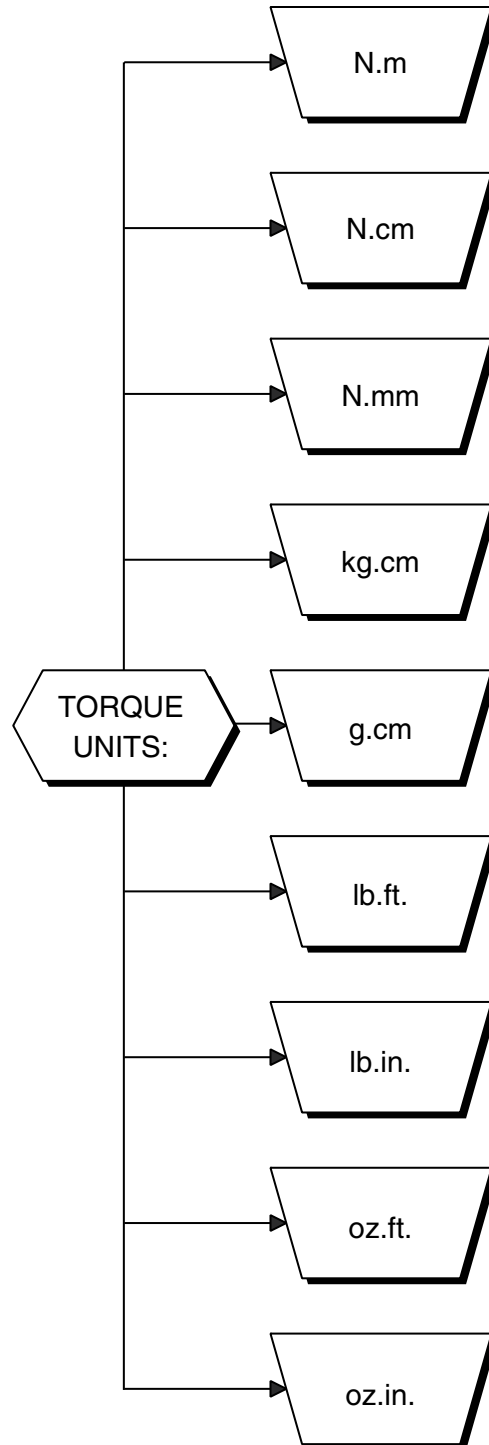

Appendix C: Schematics

C.1 ENCODER/SWITCH BOARD

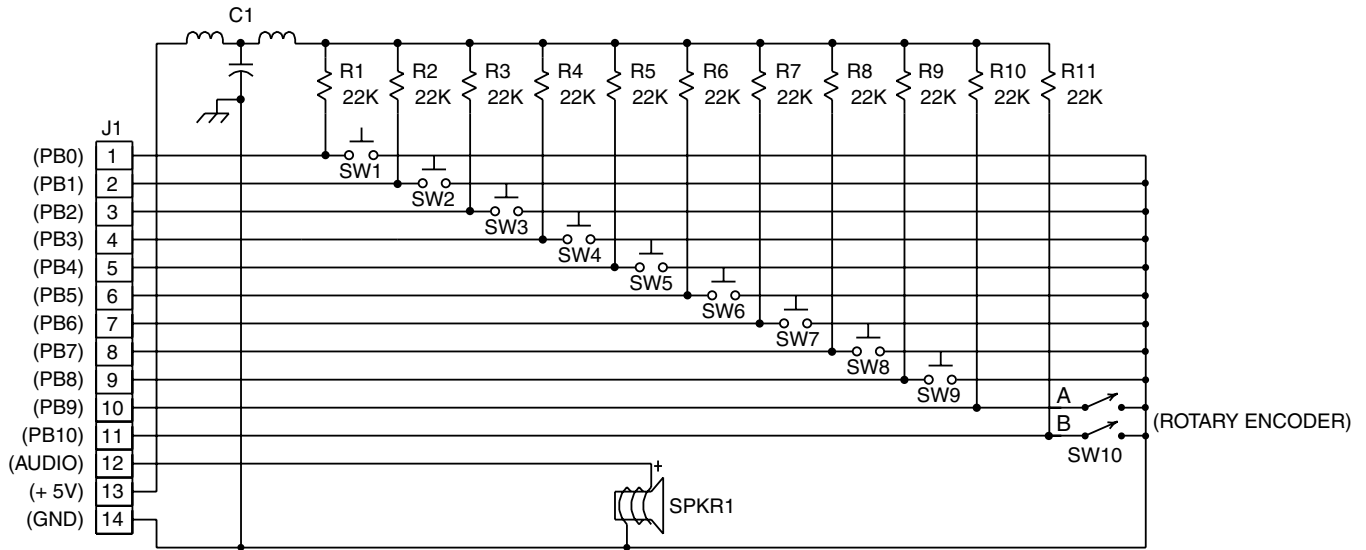

C.2 POWER SUPPLY

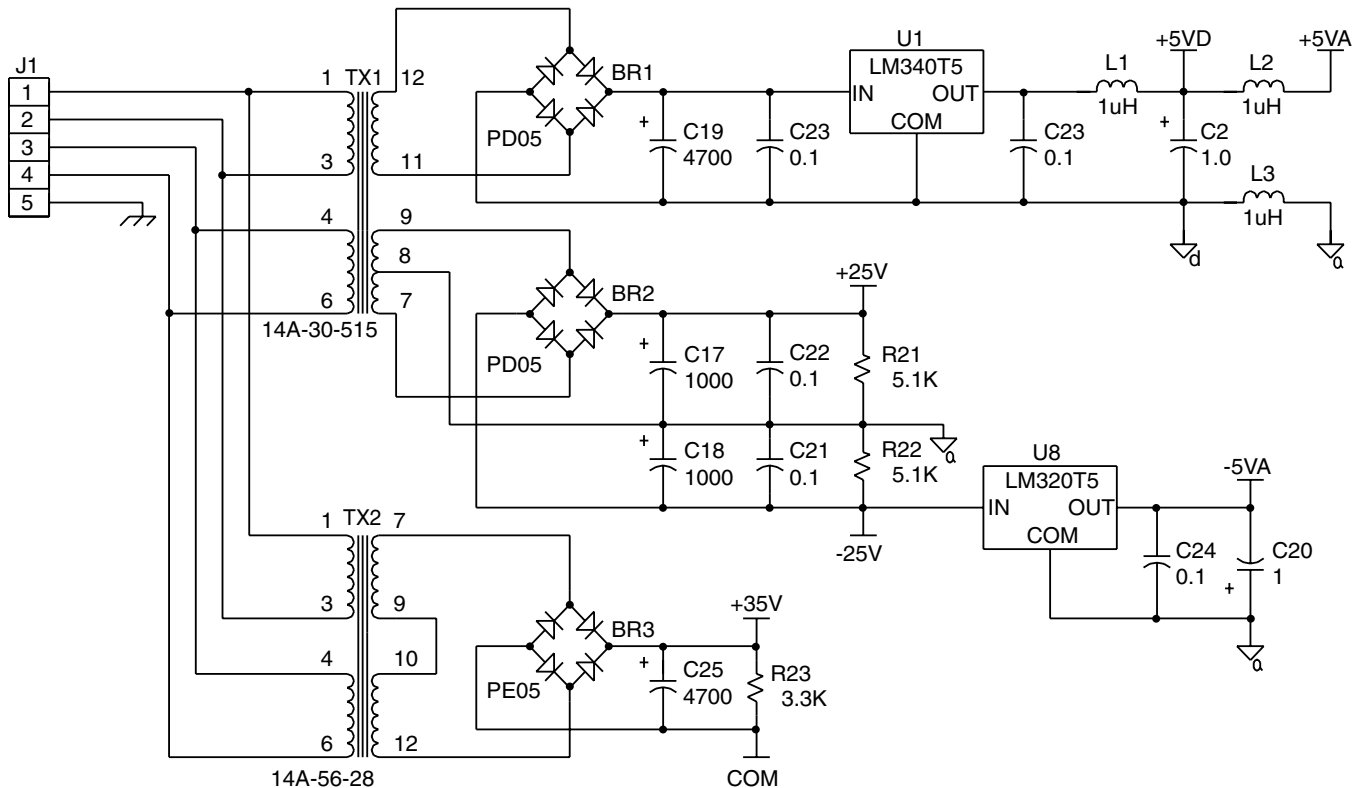

C.3 DSP & MEMORY

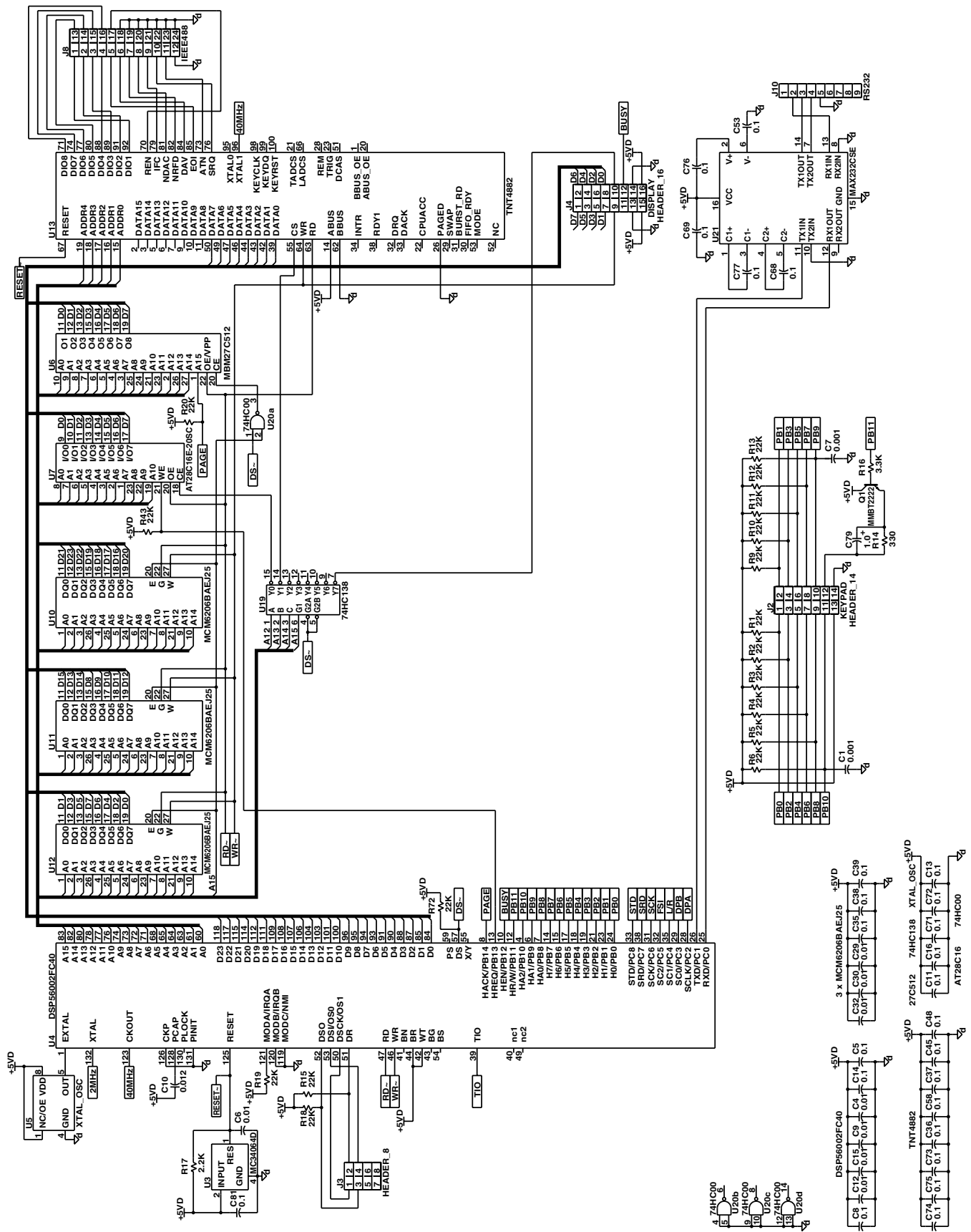

C.4 ANALOG I/O

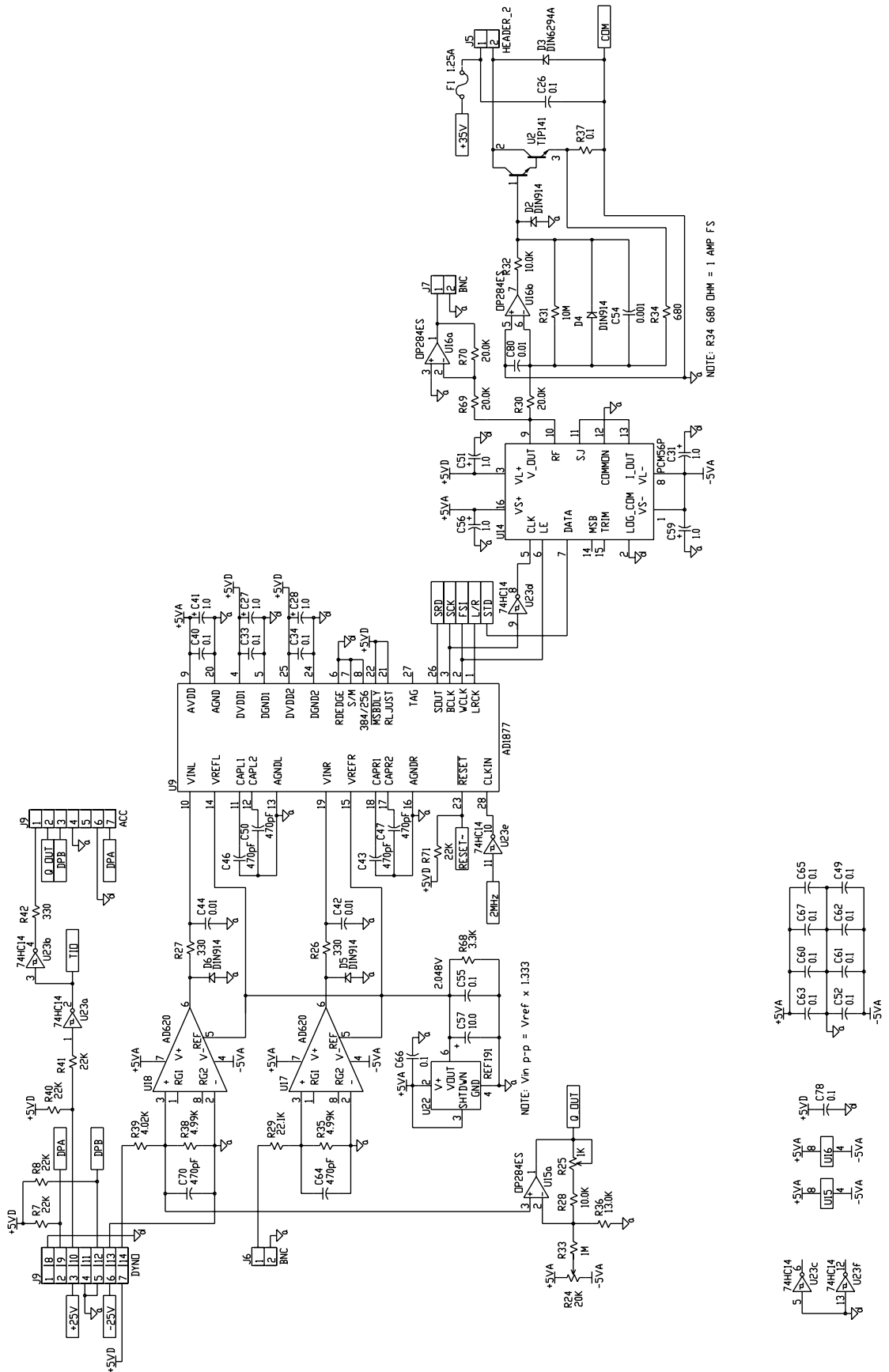

Service Information

RETURNING MAGTROL EQUIPMENT FOR REPAIR AND/OR CALIBRATION

Before returning equipment to Magtrol for repair and/or calibration, please visit Magtrol's Web site at <http://www.magtrol.com/support/rma.htm> to begin the Return Material Authorization (RMA) process. Depending on where the equipment is located and which unit(s) will be returned, you will be directed to either ship your equipment back to Magtrol, Inc. in the United States or Magtrol SA in Switzerland.

Returning Equipment to Magtrol, Inc. (United States)

When returning equipment to Magtrol, Inc.'s factory in the United States for repair and/or calibration, a completed Return Material Authorization (RMA) form is required.

1. Visit Magtrol's Web site at <http://www.magtrol.com/support/rma.htm> to begin the RMA process.
2. Complete the RMA form online and submit.
3. An RMA number will be issued to you via e-mail. Include this number on all return documentation.
4. Ship your equipment to:
MAGTROL, INC.
70 Gardenville Parkway
Buffalo, NY 14224
Attn: Repair Department
5. After Magtrol's Repair Department receives and analyzes your equipment, a quotation listing all the necessary parts and labor costs, if any, will be faxed or e-mailed to you.
6. After receiving your repair estimate, provide Magtrol with a P.O. number as soon as possible. A purchase order confirming the cost quoted is required before your equipment can be returned.

Returning Equipment to Magtrol SA (Switzerland)

If you are directed to ship your equipment to Switzerland, no RMA form/number is required. Just send your equipment directly to Magtrol SA in Switzerland and follow these shipment instructions:

1. Ship your equipment to:
MAGTROL SA
After Sales Service
Route de Montena 77
1728 Rossens / Fribourg
Switzerland
VAT No: 485 572
2. Please use our forwarder : TNT • 1-800-558-5555 • Account No 154033
Only ship ECONOMIC way (3 days max. within Europe)
3. Include the following documents with your equipment:
 - Delivery note with Magtrol SA's address (as listed above)
 - Three pro forma invoices with:
 - Your VAT number
 - Description of returned goods
 - Noticed failures
 - Value - for customs purposes only
 - Origin of the goods (in general, Switzerland)
4. A cost estimate for repair will be sent to you as soon as the goods have been analyzed. If the repair charges do not exceed 25% the price of a new unit, the repair or calibration will be completed without requiring prior customer authorization.



Testing, Measurement and Control of Torque-Speed-Power • Load-Force-Weight • Tension • Displacement

www.magtrol.com

MAGTROL INC

70 Gardenville Parkway
Buffalo, New York 14224 USA
Phone: +1 716 668 5555
Fax: +1 716 668 8705
E-mail: magtrol@magtrol.com

MAGTROL SA

Route de Montena 77
1728 Rossens/Fribourg, Switzerland
Phone: +41 (0)26 407 3000
Fax: +41 (0)26 407 3001
E-mail: magtrol@magtrol.ch

Subsidiaries in:

Germany • France
China • India

Worldwide Network
of Sales Agents

