

THE INFORMATION DISCLOSED HEREIN WAS ORIGINATED BY AND IS THE PROPERTY OF MAGTROL SA. MAGTROL SA RESERVES ALL PATENT, PROPRIETARY, DESIGN, USE, SALE, MANUFACTURING AND REPRODUCTION RIGHTS THERETO.

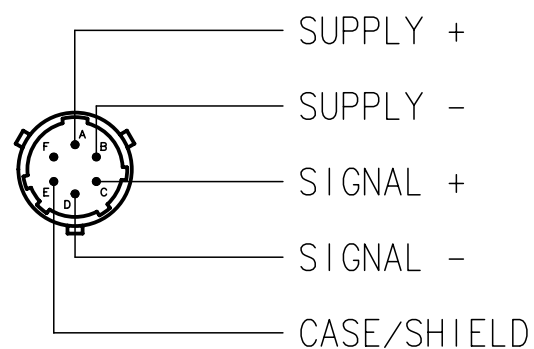
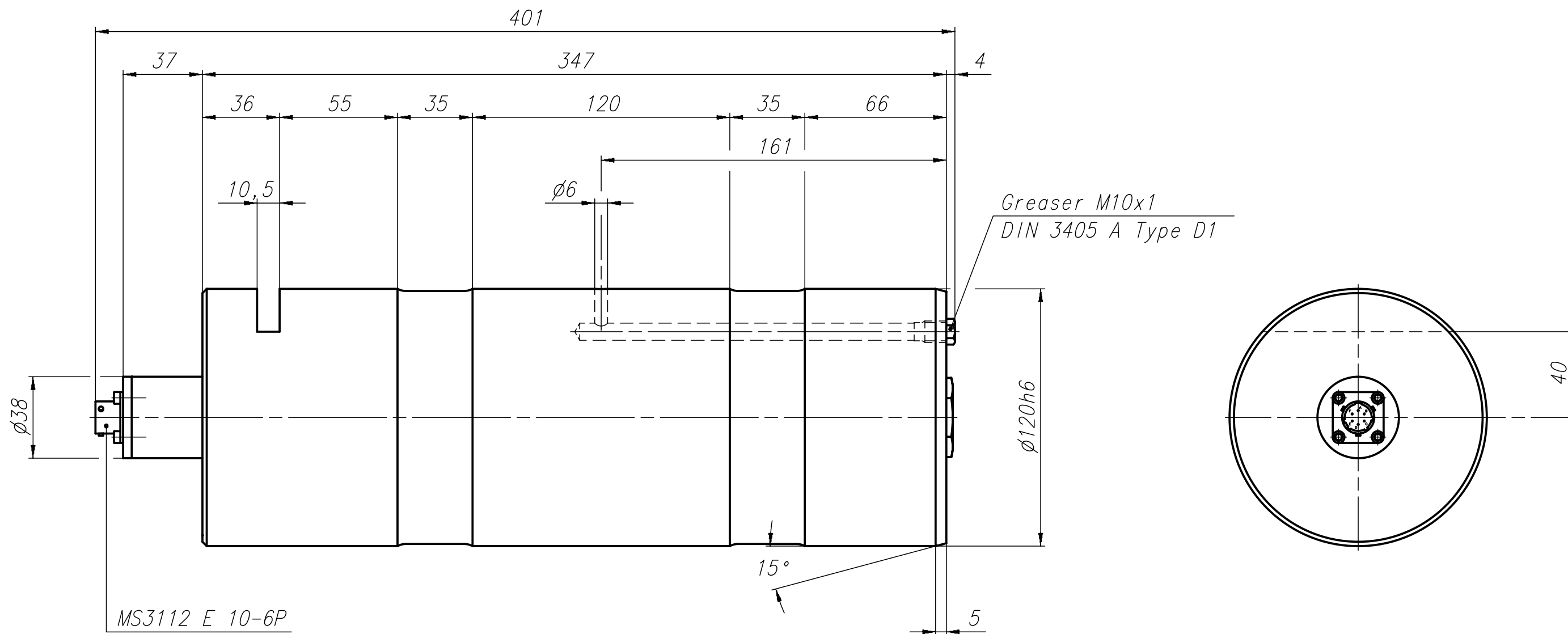

6										
5										
4										
3										
2										
1										
Rev.	Date	PM	Drawn	Appr.	Repl. by :					
					Repl. for:					
Tolerances: ± mm to 50 mm; ± mm over 50 mm								MAGTROL SA		
Material: 1.4057						Scale 1:2		Drawn	19.09.03	C.S.
Finish :								Checked		
								Approved	19.09.03	N.Buri
LOAD MEASURING PIN WITH ELECTRONIC 0-10V 1250kN						DRAWING N°				
P/N: 422-221-000-13X						TYPE: LU 221/13X		422-221-000V131		