

THE INFORMATION DISCLOSED HEREIN WAS ORIGINATED BY AND IS THE PROPERTY OF MAGTROL SA. MAGTROL SA RESERVES ALL PATENT, PROPRIETARY, DESIGN, USE, SALE, MANUFACTURING AND REPRODUCTION RIGHTS THERETO.

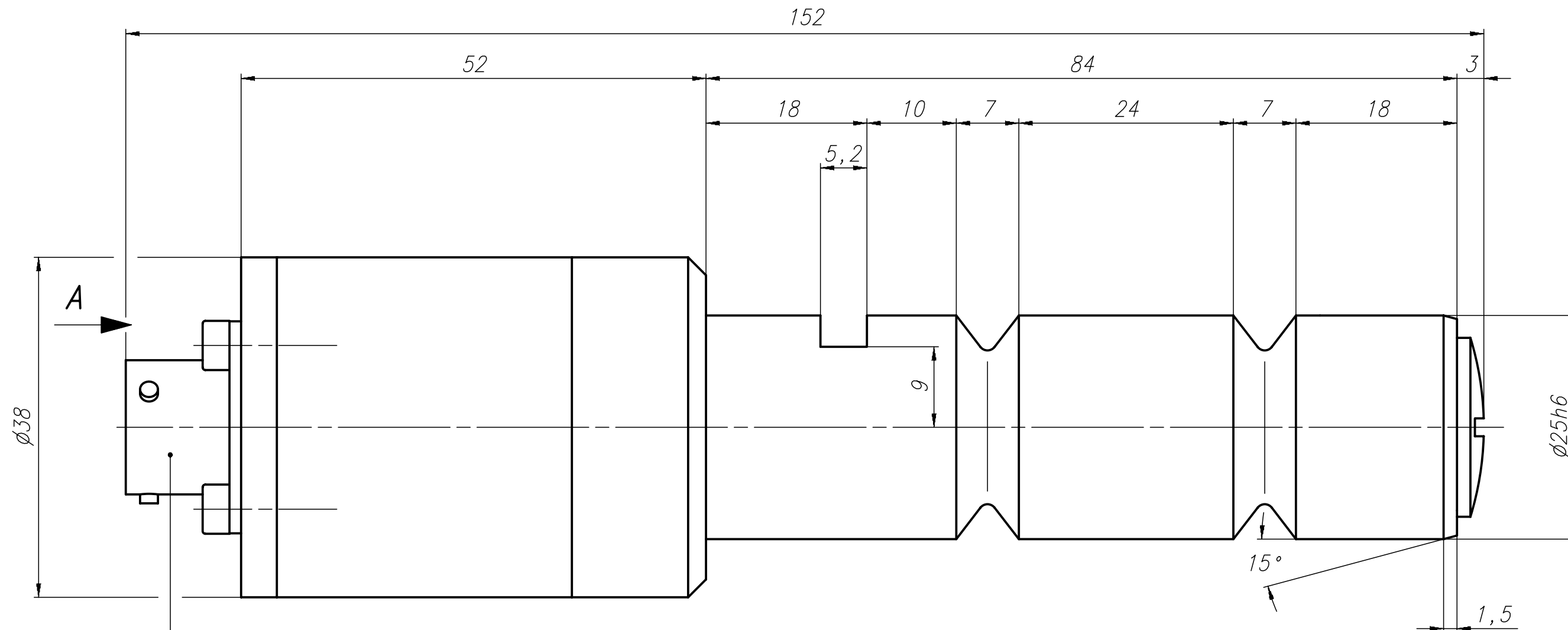

MS3112 E 10-6P

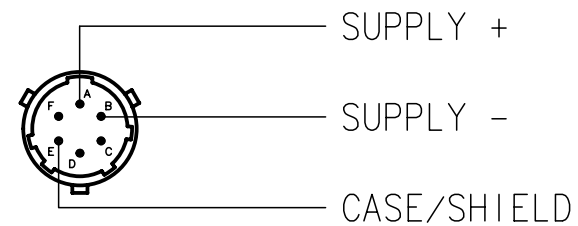
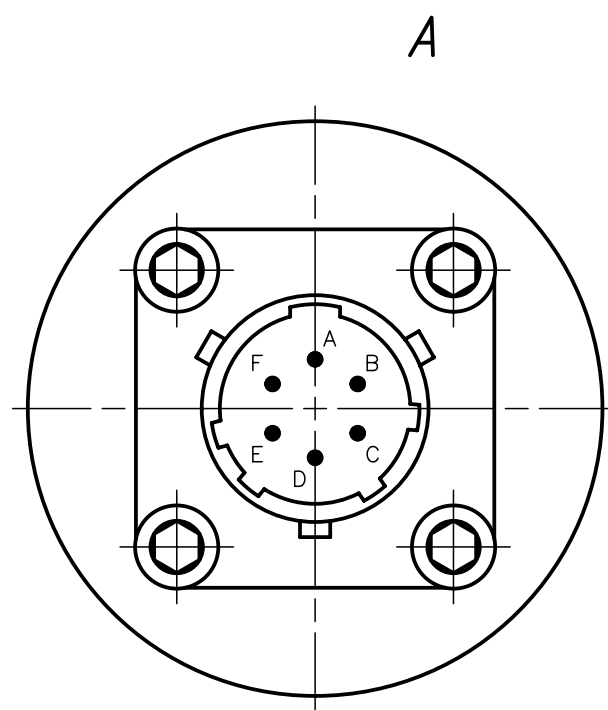

6										
5										
4										
3										
2										
1										
Rev.	Date	PM	Drawn	Appr.	Repl. by :					
					Repl. for: 422-211-000V011 (PM-02086)					
Tolerances: ± mm to 50 mm; ± mm over 50 mm								MAGTROL SA		
Material: 1.4057						Scale 2:1		Drawn	02.04.03	C.S.
Finish :								Checked		
								Approved	08.04.03	N.Buri
LOAD MEASURING PIN WITH ELECTRONIC 4-20 mA 5kN						DRAWING N°				
P/N: 422-211-000-01X						TYPE: LE 211/01X		422-211-000V013		